



PowerMOVE Mini
touch&move 3.1

user manual

PowerMOVE Mini hoist

This user manual applies to the following models

Spreader bars

4-point electric spreader bar
2-point spreader bar

Optional

Weighing unit



Warning! Always read the entire user manual before using the product.

The hoist should only be used by qualified caregivers with adequate knowledge of the operations to be carried out. If you have any questions about the use or the application, please contact the supplier.

© JOYinCARE 2023

JOYinCARE products are patented. Information about our patents can be provided upon request. We are alert to new developments, therefore technical specifications are subject to change without notice. The latest version of this user manual can always be downloaded from our website. The content of this user manual may not be copied either in whole or in part without our consent.



JOYinCARE BV

Industrieweg 47
8071 CS Nunspeet
The Netherlands
info@joyincare.com
www.joyincare.com



Contents

1. Introduction.....	3
2. General product description	7
3. Product description PowerMOVE Mini touch&move	9
4. Use of the PowerMOVE Mini touch&move	13
5. Inspection & maintenance	20
6. Troubleshooting	22
7. Contact details JOYinCARE	22
Annex A: Technical specifications	23
Annex B: Identification labels.....	25

1. Introduction

This chapter provides general information about the PowerMOVE Mini hoist and explains the symbols used in this manual. Please read this user manual completely before using the PowerMOVE Mini hoist. Before lifting a patient, always familiarise yourself with the lifting operation by practicing it together with a colleague or asking a transfer specialist for instructions.

- Read these instructions carefully before using the PowerMOVE Mini hoist;
- Also read the user manual of the sling;
- Use the hoist and sling in accordance with these instructions;
- In case of any doubts, please contact us;
- For an ongoing safe usage of the hoist, it is essential to carry out maintenance on an annual basis. Maintenance on JOYinCARE hoists should only be carried out by suitably qualified personnel.

1.1 Related documents

In addition to this user manual, which also includes daily cleaning and safety checks, a comprehensive service manual is available for the PowerMOVE Mini hoist. For the safe usage of a patient sling, it is also very important to read the user manual of the sling.

1.2 Symbols

The following symbols are used in this user manual:



Read the text carefully before working with the hoist. If the text is only relevant for a specific version, this is clearly indicated.



A tip or point of attention



Risk of damage to hoist if instructions are not followed carefully.



Risk of serious injury to patient or caregiver if instructions are not followed carefully.

1.3 Definitions

The following definitions are used in this user manual:

Patient	The person who is lifted/moved with the hoist in a sling.
Caregiver	The person who operates the hoist and provides care for the patient.
Transfer	The process of lifting, moving and properly positioning of the patient.
Sling	A body-support unit that supports the patient during the transfer with the hoist. The sling is attached to the hoist's spreader bar with loops or safety clips. Intended use of the hoist

A hoist is designed for transferring someone who has limited mobility or no mobility at all from a lying to a seated position (e.g. from bed to wheelchair). Mobile hoists are only intended for transfers – involving lifting, moving and lowering – of only one person at a time. A hoist is not meant as a means of transport and should therefore only be used for moving patients over short distances, for example from (wheel)chair to bed or from bedroom to bathroom. The PowerMOVE Mini is fitted with a 4-point electric spreader bar as standard.

A hoist should always be used in combination with a sling. The sling can be attached to the spreader bar of the hoist with either loops or safety clips. This can be a sling from JOYinCARE or another compatible brand. The patient should be closely monitored during the transfer and should never be left unattended in the hoist. The caregiver should be demonstrably competent before using the hoist. The hoist can be operated by a single caregiver.

The PowerMOVE Mini is a passive hoist designed for lifting passive patients with reduced mobility from a lying or seated position, e.g. a (wheel)chair or bed. The hoist should always be used in combination with a passive sling. The PowerMOVE Mini is not suitable for patients to whom the transfer causes significant pain, anxiety and/or discomfort, or when hyperkinesia leads to dangerous situations.

1.4 Intended use touch&move

The active and passive patient hoists of JOYinCARE have touch&move driving support. This is a smart solution for tackling physical stress and strain, reducing the risk of physical complaints. The innovative electric drive is highly intuitive and makes working with a hoist a much less strenuous, more pleasant experience. A gentle push against the push handle is enough to set the additional wheel under the hoist in motion. This wheel amplifies the force exerted forwards, backwards or sideways, making it way easier to manoeuvre the hoist.

1.5 Safety

This hoist is a medical device (class I) and is manufactured and tested according to NEN-EN-ISO 10535. The hoist complies with MDR Regulation (EU) 2017/745 and has a CE mark, which is applied to the label of the hoist. Adjustments to the hoist other than repairs may only be carried out by the manufacturer.

The maximum lifting weight of the PowerMOVE Mini depends on the model and sling:

Fitted with 4-point electric spreader bar	200 kg
Fitted with weighing unit (model JOYinCARE)	150 kg
Fitted with 2-point spreader bar	150 kg

Before using the hoist, always check the maximum lifting weight on the labels of the sling and spreader bar. If the sling or spreader bar has a lower maximum lifting weight than the hoist, the lowest maximum lifting weight should be adhered to.

	Never lift more than one patient at a time.
	Do not leave the patient unattended in the hoist.
	The hoist is not suitable for use in the shower, large jets of water can cause serious malfunctions.
	The safe use of slings from JOYinCARE in combination with the hoist has been extensively tested and documented. These slings can be recognised by the JOYinCARE logo on the label of the sling. When using another brand of sling, it is wise to check whether this combination has been tested and confirmed to be safe.
	Pay close attention to the difference between loop and clip attachment. Slings with loops can only be attached to the hooks on the spreader bar, whereas clips can only be attached to the studs of the 4-point electric spreader bar.
	Do not expose the hoist to temperatures below 10° and above 50° Celsius.
	Do not expose the hoist to humidity below 40% and above 70%.
	Never lift patients above the maximum lifting weight, the lowest maximum lifting weight of the accessories used is leading for the maximum lifting weight of the whole combination.

	Check the hoist regularly on loose parts or wear, for example of rubbers, wheels, or plastic housings. Stop using the hoist when any defects are detected and contact the technical service or supplier.
	To charge the battery, only use the supplied battery charger and power cord.
	The battery charger is designed for use in a dry environment. Do not charge the battery in the bathroom or other wet areas.
	The hoist's battery discharges itself slowly. To prevent battery damage, it is recommended to charge the battery at least every three months, even if the hoist is not in use. See further sections on battery charging of the PowerMOVE Mini touch&move.

	Always make sure the hoist is switched off before carrying out maintenance. This prevents the hoist from unexpected movements possibly leading to injuries. For more information, see the service manual.
	Annual maintenance of the hoist is essential for an optimal and safe usage of the hoist and guarantees a long product lifetime, also read chapter 5.

1.6 Warranty

The expected lifetime of the hoist is 10 years under conditions of normal use and maintenance as described in the manual. Hoists that have been adjusted by anyone other than the manufacturer will be rejected at inspection.

JOYinCARE offers a two-year warranty on the hoist. Consumable parts are not included. The warranty does not apply to damage or defects that may arise on the hoist due to incorrect or improper use and repairs carried out by unqualified persons. The assessment of this lies with the manufacturer or with its designated representative.

1.7 Liability

JOYinCARE assumes no liability for consequential damages in case of malfunctions or breakdowns and is not responsible for unsafe situations, accidents and damages resulting from:

- Not following the instructions included in this user manual, the user manual of the sling and the service manual;
- Using the hoist for applications other than those described;
- Making changes to the hoist and using replacement parts other than those prescribed.



Any serious incident related to the device, regardless of the cause, should be reported to the manufacturer as soon as possible in accordance with MDR Regulation (EU) 2017/745.

A serious incident is defined as an incident that directly or indirectly resulted or could have resulted in:

- a. The death of a patient, user or other person;
- b. A temporary or permanent serious deterioration in the health condition of the patient, user or other person;
- c. A serious threat to public health.

2. General product description

2.1 General

The PowerMOVE Mini is a passive hoist designed for lifting passive patients with reduced mobility from a lying or seated position, e.g. a (wheel)chair or bed. The hoist has a high lifting reach, enabling a patient to be lifted from the floor as well as from a higher sitting or lying element. Thanks to the translational column, the patient is – regardless of the height – always lifted at the same distance from the mast, and can therefore be positioned very precisely. The hoist should always be used in combination with a passive sling.

The PowerMOVE Mini hoist with touch&move driving support comes with a 4-point electric spreader bar, fitted with clip attachment points (studs) and is suitable for slings with safety clips. The PowerMOVE can also be fitted with a 2-point spreader bar, suitable for slings with loops. The arrow in Figure 1 indicates the forward driving direction.



Figure 1. PowerMOVE Mini touch&move 3.1

2.2 4-point spreader bar

The PowerMOVE Mini is fitted with an electric spreader bar as standard. The spreader bar has four mushroom-shaped studs, to which the safety clips of the sling can be attached. To lift a patient safely, all four safety clips should always be attached.



For the safe use of all functionalities during the transfer, please consult chapter 4 of this manual and the user manual of the corresponding sling.



The 4-point electric spreader bar with studs is only suitable for use in combination with slings with clips. A 2-point spreader bar with hooks is only suitable for use in combination with slings with loops.

2.3 Operating the lifting arm with spreader bar

Both the control panel and the separate hand control have six buttons. Buttons (1) show the symbols for ↑ moving up and for ↓ moving down. Pressing and holding these buttons will raise or lower the lifting arm.

2.4 Operating the electric spreader bar

The electric spreader bar can be tilted backwards for a lying position and forwards for a seated position of the patient. The movement can be activated by pressing the left or right button with tilting symbol. (2) Multiple functions can be done at the same time, such as raising/lowering the lifting arm and tilting the spreader bar. When several functions are used sequentially, it is important to switch smoothly between the buttons for a correct operation.

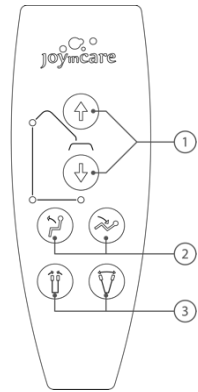

2.5 Operating the chassis legs and brakes

The width of the legs of the hoist can be adjusted for an easy access of the (wheel)chair or other device or piece of furniture. Use the hand control and press the right button with legs symbol (3) for spreading the legs. The left button can be used for closing the legs. For driving and manoeuvring the hoist, it is recommend to put the legs in the smallest position.

The two castors at the back are fitted with brakes which can be operated by foot. Push the brake pedal down to lock the brake, pull it up to unlock the brake.

2.6 Emergency lowering

Should the hoist unexpectedly fail to raise or lower, the emergency lowering function allows the patient to be manually placed on a bed or chair.

Activate the emergency button and take the orange hex key from the stiffener case on the mast. Insert the hex key into the bolt on top of the mast. Turn the hex key counterclockwise to lower the patient. Raising is possible by turning the hex key in the other direction.

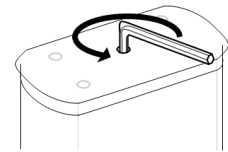

	<p>While using the emergency lowering function, never try to operate the hoist in any other way at the same time. First make sure that the patient is safely placed back in the chair or bed. Take the hoist out of use immediately and ask the technical service or supplier to check the hoist for any defects.</p>
---	---

3. Product description PowerMOVE Mini touch&move

3.1 General

The PowerMOVE Mini touch&move consists of the following parts:

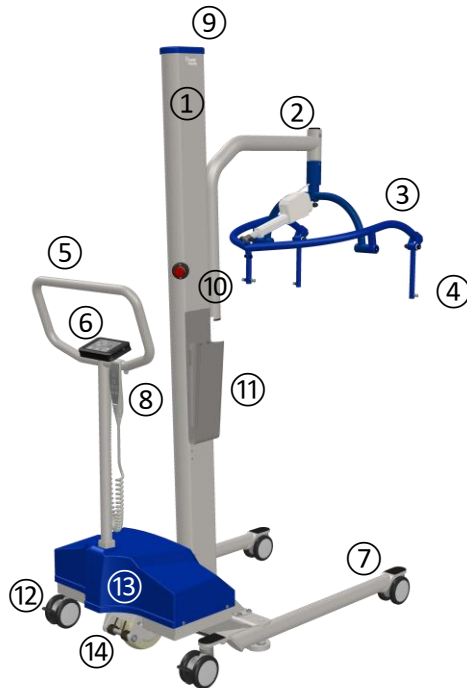

1.	Mast	8.	Separate hand control
2.	Lifting arm	9.	Emergency lowering function
3.	4-point spreader bar	10.	Emergency button
4.	Attachment points sling	11.	Stiffener case with hex key
5.	Push handle	12.	Swivel castor with brake
6.	Control panel with charging point	13.	touch&move electronics box
7.	Chassis legs	14.	touch&move wheel

The unique feature of the touch&move hoist is the electric driving support, which makes working with the hoist easier and physically less demanding for the caregiver. A gentle push against the push handle is enough to activate the additional wheel under the hoist. This makes it easier to set the hoist in motion and to manoeuvre in small spaces. touch&move is a smart solution for tackling physical strain, reducing the risk of physical complaints.

The touch&move wheel is located under the electronics box and between the two swivel castors at the back. By giving a slight push against the push handle, the touch&move wheel automatically turns into the desired direction of movement. The wheel turns both forwards and backwards and up to 90 degrees sideways.

3.2 Points of attention

	The blue housing of the electronics box should only be removed by suitably qualified personnel. This also applies to changing the touch&move wheel and batteries.
	Only hold the push handle once the hoist is fully started.
	It takes a few seconds for the hoist to become operational, do not hold the push handle during the start-up.
	Do not hang clothes or slings on the push handle during operation.
	Avoid applying large (peak) forces on the push handle, the sensor may react unexpectedly as a result.
	Do not use the hoist if the orange maintenance light is permanently on. If this occurs during a transfer, complete the transfer calmly, then have service carried out by suitably qualified personnel.
	Video instructions on how to use the touch&move hoist can be found on the website of JOYinCARE.

3.3 Control panel

The PowerMOVE Mini touch&move is fitted with both a control panel and a separate hand control. The image below shows the control panel mounted on the push handle on the left and the hand control on the right.

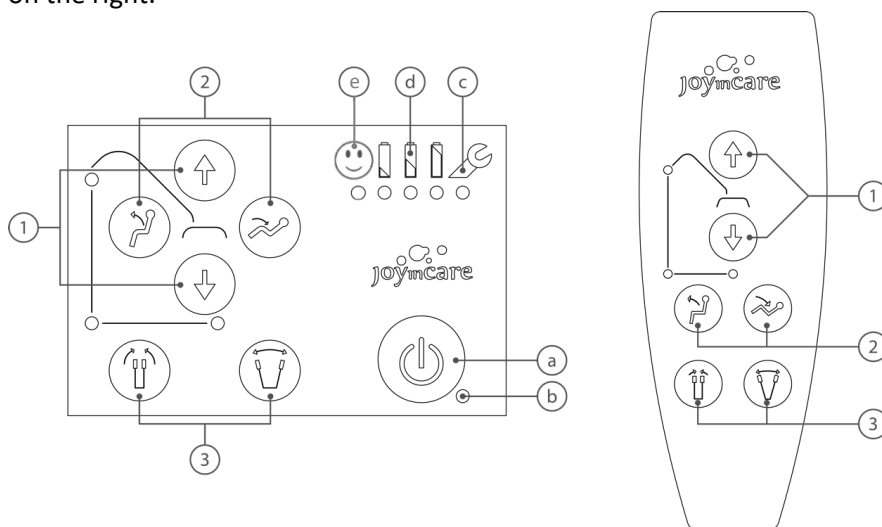

1) Height lifting arm and spreader bar	a) On/off button
2) Tilting spreader bar	b) On/off indication
3) Opening/closing chassis legs	c) Maintenance indication
	d) Battery status indication
	e) Proper usage indication

Symbols 1, 2 and 3 are identical for both operating modes. See chapter 2 for the use of the functions.

3.4 Activation

The On/off button (a) activates all functions of the PowerMOVE Mini touch&move. Press the button for 2 seconds, then all indication lights on the control panel will light up. Do not hold the control panel or push handle and make sure that the push handle isn't touched. It takes 5 seconds for the touch&move driving support to become operational. Once the Device indication light (b) turns green, all functions are ready for use and the push handle may be held.

If the PowerMOVE Mini touch&move is not used for a longer period of time, it is recommended to switch it off by pressing and holding the On/off button. After 15 minutes, the device indication light starts flashing green, meaning the hoist will go into sleep mode. As soon as it is touched or used, the hoist will resume full operation. Should the hoist not be used for more than 30 minutes, all functions will switch off automatically. The hoist should then be switched on again before use.

3.5 Driving and manoeuvring with touch&move

The push handle of the PowerMOVE Mini touch&move is fitted with a sensor, which measures the direction and amount of force pushed against the push handle.

- To drive in a straight line: gently push against the push handle, the hoist will start moving automatically;
- To drive backwards: gently pull the push handle, the hoist will move in a backwards direction;
- To drive diagonally forwards and backwards: gently indicate the direction and let the touch&move driving support do its work;
- To travel sideways: first bring the hoist to a standstill and then push against the side of the push handle. The wheel will automatically turn in the desired direction and start moving. Try whether it is comfortable to stand next to the lift while doing this;
- After reaching the desired position, release the push handle, the wheel will automatically return to the forward position after 2 seconds.

3.6 Proper usage indication

The touch&move driving support has been developed to reduce physical strain while driving and manoeuvring hoists. Besides using the right type of hoist, proper use of the hoist is also important. The proper usage indication (e) on the control panel makes it clear whether the hoist is being used in the right way. The indication light under the smiley on the control panel lights up green when sufficient force is applied and the hoist is operated correctly and calmly.

Applying too much force or making unwanted movements are a strain on your body and will make the indication light turn red. The hoist will also give a warning for incorrect use by means of a beeping signal.



To reduce physical strain, ensure that the proper usage indication light (e) remains green during use. Driving and manoeuvring with touch&move is easiest when the push handle is pushed gently and in a clear direction. This gives the electric driving support enough time to get and keep the hoist moving. Making a turn works best by standing next to the hoist and steering with one hand on the lifting arm.

	<p>When excessive force is applied to the push handle, the tilt function will automatically activate to protect the hoist from unwanted use. The on/off indication light will light up red and a beeping signal will sound. Restart the hoist to resume use.</p>
---	--

3.7 Emergency button

To stop all movements, press the red emergency button on the mast. Use the emergency button only in emergency situations. Turn the emergency button clockwise to reactivate normal operation.

	<p>Use the emergency button only in case of emergency. Activation of the emergency button will activate the alarm signal. To switch off the hoist, use the on/off button on the control panel or wait until the hoist switches off automatically.</p>
---	---

3.8 Battery status indication

The battery status lights (d) on the control panel have the following meanings:

- 1) All three battery status lights are green: battery is fully charged;
- 2) Two battery status lights are green: battery level is 45-70%;
- 3) One battery status light is green: battery level is 20-45%;
- 4) One battery status light is continuously red: battery level is <20%;
 - Complete the transfer calmly;
 - Start charging the battery as soon as possible;
- 5) One battery status flashes red: battery is almost empty;
 - Complete the transfer calmly;
 - The spreader bar / lifting arm can no longer be raised, only lowered;
 - The legs can still be widened / narrowed;
 - A beep signal sounds with each movement initiated;
 - The touch&move driving support is switched off;
 - Start charging the battery as soon as possible.

3.9 Charging the battery

The integrated battery of the PowerMOVE Mini touch&move 3.1 can be charged with the included battery charger. It can be recognised by the JOYinCARE sticker and is fitted with an angled plug.

Drive the hoist to the desired location with a socket. Plug the charger into the charging point on the right side of the control panel and connect it to the socket. A red light on the battery charger will light up as a sign that the battery is being charged. As soon as the light turns green, the battery is full. It takes 6 hours to fully charge the battery. Make sure the emergency button is not activated during charging. After charging, disconnect the charger from the socket, remove the charging connector and the hoist is ready to use again.

While charging the battery, the hoist will automatically switch off and cannot be used. If the hoist is switched on during charging, the battery status lights will turn green, after which the hoist will switch off again. Before using the hoist, always disconnect the charger from the socket and unplug the charger from the hoist.

3.10 Maintenance

If the maintenance indication light (c) lights up, a power failure has occurred in the touch&move wheel. Should it light up during a transfer, complete the transfer calmly and make sure maintenance is carried out by suitably qualified personnel.

4. Use of the PowerMOVE Mini touch&move

4.1 General

It is important to be well prepared before using the hoist and the sling. Therefore, also read the user manual of the sling carefully before use. In addition, it is recommended to first practice the operation without a client, but with a colleague for example. It is important to experience the transfer with a hoist and sling yourself. This gives the necessary confidence to perform the transfer with a patient.

Before using the hoist, check whether the indication lights give no warnings and the battery is sufficiently charged. Make sure that the battery charger plug is disconnected before moving the hoist and check whether the emergency button is deactivated by turning it clockwise.

	Check the medical file for any physical changes of the patient and the number of caregivers the transfer should be made with.
	Have the correct type and size of the sling ready. To determine the right type and size follow the instructions in the sling's user manual.
	Check beforehand that the sling has no damage; it is essential that the material, stitching, seams, bias binding and safety clips or loops are undamaged. Damaged slings should be taken out of use immediately.
	Check that the sling is suitable for use on the PowerMOVE Mini with the attached spreader bar and that the stiffeners are used.

4.2 Sling attachment

Depending on the spreader bar, a sling can be attached by means of safety clips or loops. The electric 4-point spreader bar can only be used in combination with a sling with safety clips. When the PowerMOVE Mini is fitted with a 2-point spreader bar with hooks, it is only suitable for attaching a sling with loops. Before use, check all clips or loops for abnormalities or defects. Do not use the sling in case of any defects or doubts.

A) Clips

The functionality of a safety clip may vary from one supplier to another. Read the user manual of the respective sling for the instructions. The Careclip of JOYinCARE works as follows:

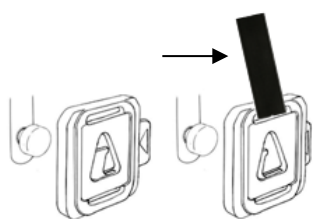

Attachment of the Careclip: Make sure there is no tension on the clip. Fully depress the slider on the side of the clip and place the created opening completely over the stud of the spreader bar. Release the slider. The slider closes the clip and the clip is now safely secured to the stud of the spreader bar. Always attach the shoulder clips first, followed by the leg clips.

Detachment of the Careclip: Make sure that the weight of the patient is taken up by the receiving surface and that there is no tension on the clip, before you detach the clip. Fully depress the slider and lift the clip completely over the stud. Always detach the leg clips first before detaching the shoulder clips.



Before lifting, always check that all clips are properly attached by visually inspecting the attachment and pulling the strap of the clip (see arrow). Raise the spreader bar slightly until there is tension on the sling and check the clips again. Do not lift the patient further until all clips have been properly checked.

Compatibility: The 4-point spreader bar is fitted with universal attachment points suitable for slings with safety clips. When combined with third-party slings, it is strongly recommended to always use slings with safety clips.

The axis of the stud has a diameter of 7 mm and a length of 6 mm, the head of the stud has a diameter of 12 mm. The span width between the shoulder suspension points is 55 cm. Always check the specifications of the specific sling whether it is suitable for use in combination with this type of spreader bar and studs. For a safe use of the hoist, the sling should also be manufactured according to NEN-EN-ISO 10535. If you have any questions about compatibility, always contact your local distributor before using the certain combination.

B) Loops

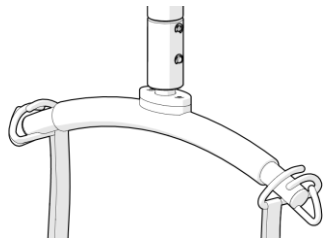

Attachment of the loops: Make sure there is no tension on the loop. Place the loop over the hook of the spreader bar. Cross the leg loops by pulling one strap through the other (do not cross the leg loops of a JOYinCARE Longseat in-situ sling). Do not cross the shoulder loops and use the same length for both shoulder loops and the same length for both leg loops. First attach the shoulder loops, then attach the leg loops.

Detachment of the loops: Make sure that the weight of the patients is taken up by the receiving surface and that there is no tension on the loop, before you detach the loop. Pull the loops over the hooks of the spreader bar. Always detach the leg loops first before detaching the shoulder loops.



Before lifting, always check that all loops are properly attached by visually inspecting the attachment and pulling the loop. Raise the spreader bar slightly until there is tension on the sling and check the loops again. Do not lift the patient further until all loops have been properly checked.

Compatibility: A patient hoist with loop attachment points can be used safely in combination with any sling with loops. For safe use of the hoist, the sling used should also be manufactured according to NEN-EN-ISO 10535. Always contact your local distributor in case of compatibility questions before using the combination.



When using a sling with both clips and loops, extra attention is required when attaching the sling. Attach the clips only to a spreader bar with studs and the loops only to a spreader bar with hooks. Using the incorrect attachment method can cause the sling to come loose and lead to serious injury.

4.3 Lifting from a lying to a seated position

Place the hoist nearby and explain to the patient what is going to happen. In case the patient is lifted with a hoist for the first time, it is recommended to demonstrate the patient together with a colleague how the lifting operation is done. Make sure the (wheel)chair is in an easy accessible place and put it on the brake. The hoist doesn't have to be on the brakes. Remove any obstacles.



Apply the sling as indicated in the user manual of the sling. The application and use may differ from supplier to supplier. In this manual, we show one of the common ways.

Applying the sling:

- 1) Apply the sling by gently rolling the patient to their side. When doing this, make sure the bed is on its brakes and at a good height to avoid unnecessary physical strain.
- 2) Roll the patient back onto the sling and pass the leg straps under the patient's thighs, one leg at a time.

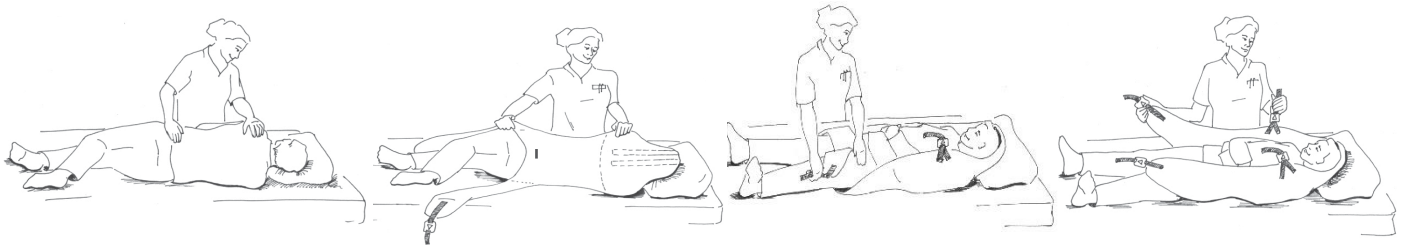

Drive the chassis of the hoist under the bed. Position the open side of the spreader bar towards the shoulders of the patient and make sure the spreader bar is high enough to avoid hitting the patient with it. For some beds it may be necessary to adjust the chassis leg width. For a smooth movement, make sure there are no cables or other obstacles under the bed. It may be pleasant for the patient to raise the backrest of the bed slightly, bringing the patient into a half-sitting position.

Attach the safety clips of the sling to the studs of the spreader bar. From a lying position, this works best when the spreader bar is also tilted backwards to a lying position. Attach the shoulder clips first and then, if necessary, tilt the spreader bar to a more seated position to easily attach the leg clips. Always check that the four safety clips are correctly attached before lifting.

The patient can now be lifted or lower the bed under the patient. Move the hoist slowly away from the bed until the tailbone and heels are completely free. If desired, turn the patient a quarter turn to face the mast. By tilting the spreader bar, the patient can be brought into a more seated position, however, slightly backwards is a more comfortable position for most patients.

	<p>While driving, ensure that spreader bar is turned so that the patient's head is at a sufficient distance from the mast and keep an eye on the patient in relation to the surroundings to avoid collisions.</p>
---	---

Drive the patient above the (wheel)chair, if necessary widen the chassis legs to position the patient right above the chair. If possible, tilt the (wheel)chair, tilt the spreader bar to the same position and lower the patient. Another option is to tilt the spreader bar to a seated position just before reaching the chair. However, this creates more pressure on the patient's legs, which is less comfortable.

Once the tension is off the safety clips, the safety clips can be detached from the spreader bar. Drive the hoist backwards in order to easily remove the sling or drive the wheelchair. If the patient has to be transferred with the hoist to another room, e.g. the bathroom, it is easier to drive the hoist with the chassis legs in the narrowest position.

	<p>Always consider carefully whether it is safe to leave the patient alone in a certain position and for what length of time. Make sure the patient can access and operate an alarm in case of emergency.</p>
---	---

Removing the sling in a seated position:

Remove the sling as indicated in the user manual of the sling. The options for removal differ according to the type of sling. A standard sling can be removed as follows:

Once the patient is properly seated and has placed the feet on the footboard or on the floor, gently pull back the leg straps one by one. If necessary, give slight pressure on the knee to prevent the patient from sliding forward in the chair. When both leg straps have been pulled back, make the patient bend forward slightly in order to easily remove the sling between the back of the chair and the patient.

4.4 Lifting from a seated to a lying position

Place the hoist nearby and explain to the patient what is going to happen. In case the patient is lifted with a hoist for the first time, it is recommended to demonstrate the patient together with a colleague how the lifting operation is done. Make sure that the (wheel)chair is in a place where the patient can be easily lifted out of the chair and be transferred to the bed. Put the wheelchair on the brake. The hoist doesn't have to be on the brakes.

Apply the sling as indicated in the user manual of the sling. Both the method of application and the position differ for each type of sling, here we explain the most common way with a standard sling.

Applying the sling:

- 1) Make the patient bend forward slightly, place the sling between the back of the (wheel)chair and the patient and push it down to the seat of the chair.
- 2) Bring the leg straps forward along the legs;
- 3) Pull the sling up to the patient's tailbone by pulling the leg strap with one hand and pushing against the knee with the other hand;
- 4) Pass the leg straps under the patient's thighs, one leg at a time.
- 5) When using a sling with loops: cross the loops of the leg straps through the first loop. Do not cross the leg loops of a JOYinCARE Long seat in-situ sling.
- 6) Place the stiffeners in the head support and attach the sling to the spreader bar.
- 7) Check that all clips or loops are securely fastened.

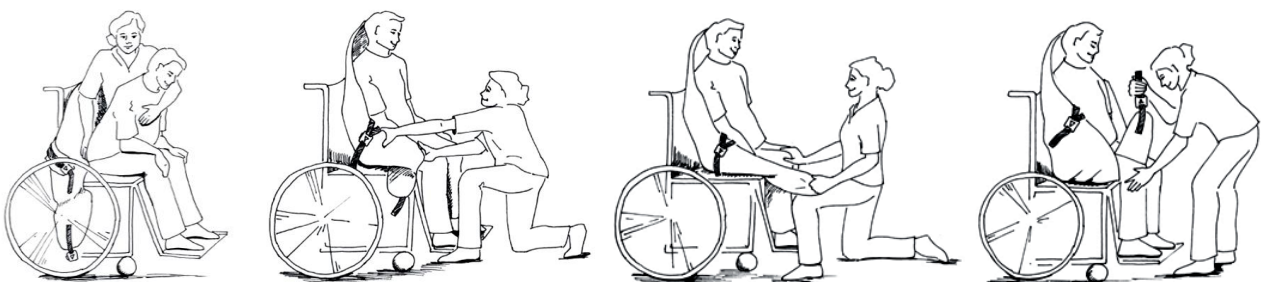

Gently drive the hoist to the patient with the spreader bar at a good height, in the seated position and with the open side facing the patient. Standing next to the patient during the movement gives the patient a greater feeling of control and safety. If necessary, lower the spreader bar slightly and attach the safety clips. Check that the four safety clips are secure and lift the patient out of the chair.

Drive the patient above the bed, making sure the tailbone and preferably also the heels are free from the bed by raising the hoist and lowering the bed. If necessary, move the back and the leg support of the bed slightly into a seated position beforehand. Lower the tilting spreader bar enough in order to detach the safety clips without force. Drive the hoist away. Remove the leg straps under the thighs and remove the sling by rolling the patient on their side, as when applying the sling in lying position.

4.5 Lifting from the floor

The PowerMOVE Mini can also be used to lift someone from the floor or to lay someone on the floor. Applying the sling can be done in the same way as in bed, only place a pillow or possibly more pillows under the patient's head. Approaching the patient with the hoist requires great precision, as the hoist has to be manoeuvred around the patient. Adjust the chassis legs to the widest position to create the most space. Depending on the length of the patient, the patient can be approached from the head side. If this is not convenient, drive the hoist at an angle from the patient's side and place the patient's legs over the chassis legs. It is recommended to do this with two caregivers. When the patient should be lifted from the floor after a fall, always check that the patient has not been injured and if the patient can be placed in a seated position. When in doubt, always ask an expert.

4.6 Lifting with a widening bar

The 4-point spreader bar can be fitted with a widening bar, intended for the use of a Long seat in-situ sling with safety clips.

- 1) Attach the clips of the widening bar to the leg attachment points of the 4-point spreader bar. See the instructions for use below.
- 2) Apply the Long seat in-situ sling as described in the user manual of the sling.
- 3) Attach the clips at the shoulders to the spreader bar and the clips at the legs to the attachment points of the widening bar.
- 4) Check that all clips of both the sling and widening bar are securely fastened.

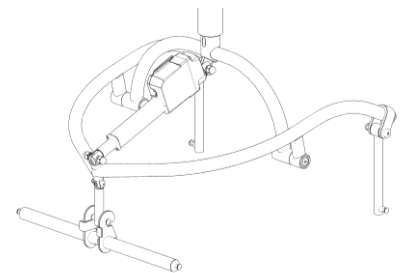

Attach the clips of the widening bar to the leg attachment points of the 4-point spreader bar by pushing down the orange bracket and placing the clips over the studs.

After use, the widening bar of the 4-point spreader bar can be removed by pushing down the orange bracket and removing the clips from the studs.

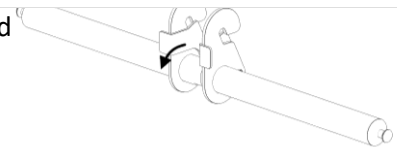

	<p>The widening bar of JOYinCARE is only suitable for a Long seat in-situ sling with safety clips from JOYinCARE in combination with a hoist with 4-point spreader bar from JOYinCARE.</p>
	<p>To prevent corrosion, the widening bar should not be used in the water/swimming pool. If corrosion occurs, the widening bar should be taken out of use.</p>
	<p>The widening bar can be loaded to a maximum of 200 kg.</p>

4.7 Lifting with a 2-point spreader bar

If the PowerMOVE Mini is fitted with a 2-point spreader bar, follow the specific instructions in the user manual of the sling. With this spreader bar, the PowerMOVE Mini works exactly as described before, only the buttons for operating the electric spreader bar do not work. The patient's posture can only be adjusted by varying the length of the loops. In order to position the patient properly in the back of the chair, it might help to gently press against the patient's knee just before the patient is seated.

	<p>A 2-point spreader bar is fitted with hooks and is only suitable for use in combination with a sling with loops.</p>
---	---

4.8 Use of JOYinCARE weighing unit

The PowerMOVE Mini can optionally be equipped with a weighing unit from JOYinCARE. The weighing unit is integrated into the lifting arm of the hoist and is fitted with break protection. The weighing unit can be recognised by its blue housing and JOYinCARE sticker.

	<p>The weighing unit has a maximum lifting capacity of 200 kg. Note: the maximum lifting weight of the hoist is leading for the maximum lifting capacity and can be found on the mast or lifting arm and spreader bar of the hoist.</p> <p>The weighing unit is not meant for medical purposes such as:</p> <ul style="list-style-type: none"> - diagnosis, prevention, monitoring, treatment or alleviation of diseases (e.g. dialysis) - diagnosis, monitoring, treatment, alleviation or compensation of injuries or disabilities - research into replacement or modification of the anatomy of a physiological process - control of fertilization.
---	--

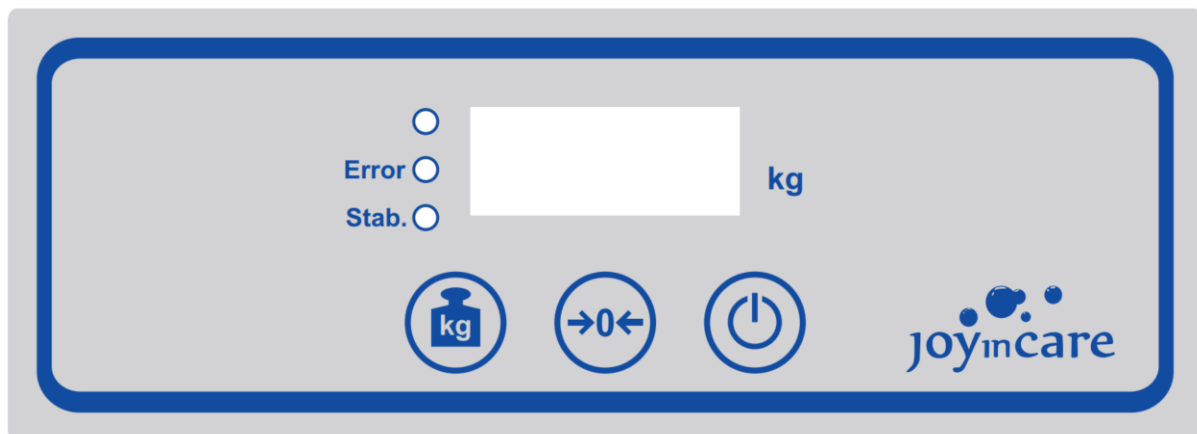

The weight of a patient can be determined by the following steps:

- 1) Move the hoist to the desired position next to the patient.
- 2) Attach the sling to the spreader bar and press the on/off button. Check whether the weighing unit has automatically set itself to 0. Setting the weighing unit manually to 0 can be done by pressing the >0< button. By attaching the sling to the spreader bar before turning on the weighing unit, the weight of the sling will not be counted during weighing.
- 3) Apply the sling and lift the patient until the patient is hovering over the surface.

- 4) Do not touch the patient, sling or spreader bar during weighing and make sure the patient hangs as still as possible. The weighing unit determines the patient's weight and shows it on the display. The indication light (Stab.) next to the display will light green at this point.
- 5) Read the weight on the display
- 6) Complete the transfer as desired.
- 7) The weighing unit switches off automatically after 5 minutes. Manual switch-off can be done by pressing and holding the on/off button.
- 8) When weighing over 200 kg, the error indication light will light red and no correct weighing is possible.

Battery and maintenance

Information about the battery percentage, software version and serial number of the weighing unit can be read by pressing the i-button. The weighing unit is equipped with a 9-volt battery. The display indicates when the battery needs to be replaced. To replace the battery, lift up the cover at the back of the weighing unit and slide out the battery holder. Remove the battery and insert a new one correctly. Slide the battery holder back and close the cover. You can also contact the technical service or maintenance partner for this.

5. Inspection & maintenance

5.1 Daily inspection

Before each use of the hoist and slings, attention should be paid to the following points.

	Check that hoist and sling are clean
	Check that the batteries are sufficiently charged
	Check that the castors of the hoist are clean and turn smoothly
	Check that all parts are properly secured and undamaged
	Check that all movements of the lift operate normally (up/down, tilting spreader bar, opening/closing chassis legs)
Check the sling before each use. Pay special attention to seams, stitching and loops. Check that the four safety clips are undamaged and that the closure is functioning correctly. Make sure that the stiffeners are in place when applicable.	

	If the above inspection reveals a deviation, do not use the hoist or sling and inform the technical service or supplier immediately.
---	--

5.2 Periodic inspection

In accordance with NEN-EN-ISO 10535, the hoist must be inspected at least once a year by suitably qualified personnel. All functional parts should be checked and at least 1 lifting cycle with the maximum lifting weight of the combination should be carried out. It is recommended to have the hoist inspected according to the guidelines described in the NEN-EN-ISO 10535 standard.

	Note: when inspecting the maximum load, the hoist should be loaded as in normal use. That is, by means of a downward force, testing the full high-low movement with the maximum weight.
---	---

5.3 Maintenance

Preventive maintenance of the hoist should also be carried out at least once a year. Maintenance of the hoist can be a consequence of the inspection but may also be carried out separately. Maintenance is necessary to enhance the safety and life time of the hoist. A detailed explanation of the maintenance is described in the service manual of the hoist. Components must be replaced in case of any damages/defects. When replacing components, only use original parts from the manufacturer, which can be found with serial number in the service manual.

The local distributor offers the option of inspecting the hoist once a year under a maintenance contract. Contact your local distributor for more details about this.

5.4 Reporting

As described in NEN-EN-ISO 10535, inspection, maintenance and any malfunctions, damage or wear of each hoist should be documented. This also applies when inspection and maintenance is outsourced to a maintenance partner.

If any defect, damage or wear is found, the hoist in question should always be taken out of use immediately until further inspection and repair has taken place.

5.5 Cleaning

It is recommended to clean and/or disinfect the hoist after use. Use a damp cloth with warm water and a non-aggressive cleaning agent. Make sure the cloth is not soaked, but wring it out. The battery and charger should only be wiped with a dry cloth.

JOYinCARE recommends the use of Mikrozyd® cleaning and disinfecting wipes.

For cleaning the sling, please consult the user manual of the sling.

	<p>Do not use aggressive or abrasive cleaning agents.</p> <p>Be careful not to get the hoist too wet. This can cause problems with electrical components or lead to corrosion. Do not put the hoist in the shower.</p>
---	--

5.6 Environmental aspects

All parts of the hoist should be recycled in accordance with the rules of the country where the hoist is used. At the end of its lifetime, the hoist can be returned to the distributor for recycling.

JOYinCARE or the distributor will ensure that these parts are processed in an environmentally friendly manner.

For the following parts, ensure that an environmentally friendly method of disposal is used:

- Electronics
- Batteries
- Plastic parts

6. Troubleshooting

Check the overview below to resolve possible problems. If the following solutions do not solve the problem, contact the technical department or the distributor. Take the hoist out of use.

6.1 PowerMOVE Mini touch&move

1. The touch&move driving support does not work

- Switch the hoist off and on again
- Check whether the emergency button has been activated.
If yes, turn the button to the right and switch the hoist back on.
- Check that the hoist is disconnected from the battery charger.
Remove the battery charger plug from the hoist and switch the hoist back on.
- Check that the hoist is switched on in the correct way.
 - Press and hold the on/off button for a few seconds.
 - The on/off button should not be hold for more than a few seconds. The hoist will then switch off again automatically.
 - Do not hold the push handle during switching on and starting up.
- Check the battery status
If the battery status indication light flashes red, the hoist needs to be charged.

2. Operation of the hoist by hand control does not work

- Check that the connector of the hand control is correctly connected.
- If there are no problems with operation by using the control panel, the problem can be solved by ordering a new hand control.

3. The hoist does not charge

- Check that the charging connector and plug are properly connected to both the hoist and the socket.
- Check that the accompanying charger is used, which can be recognised by the JOYinCARE sticker.

4. A beeping signal sounds

- Check whether the emergency button is activated.
- Deactivate the emergency button by turning it to the right and switch the hoist back on.

7. Contact details JOYinCARE

Manufacturer

JOYinCARE BV
Industrieweg 47
8071 CS, Nunspeet
The Netherlands

info@joyincare.com
www.joyincare.com



Annex A: Technical specifications

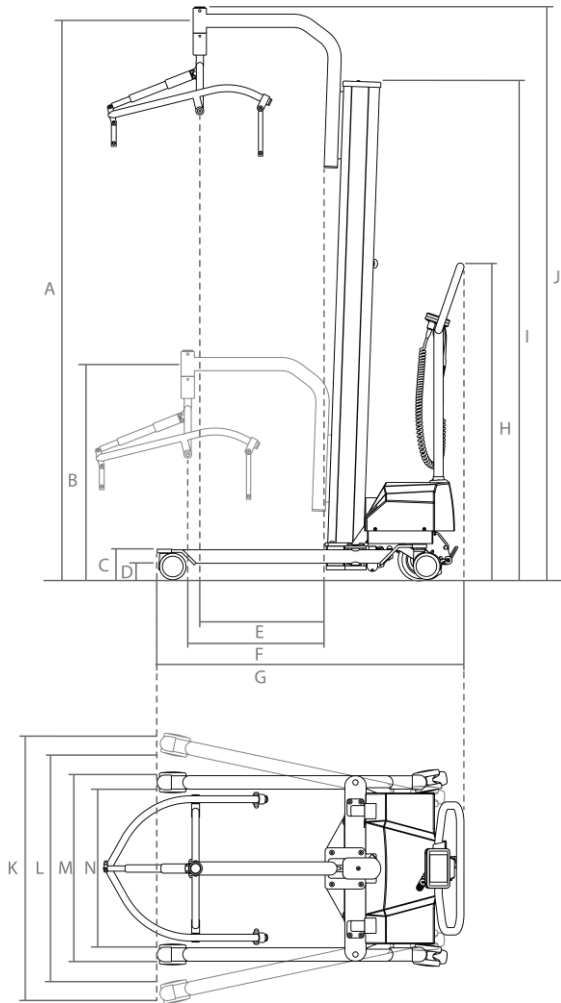

Figure 1. PowerMOVE Mini touch&move 3.1

PowerMOVE Mini touch&move 3.1			
	Part	Specifications	
A	Highest position lifting arm	207	cm
B	Lowest position lifting arm	78	cm
C	Height of the chassis legs	11.5	cm
D	Space under the chassis legs	6	cm
E	Reach lifting arm at highest position	47	cm
F	Reach lifting arm at lowest position	51.5	cm
G	Full length	118.5	cm
H	Push handle height	120	cm
I	Minimum total height	188	cm
J	Maximum total height	212	cm
K	Maximum width	95	cm
L	Internal width at maximum spread	80	cm
M	Minimum width	70	cm
N	Internal width at minimum spread	60	cm
-	Maximum turning radius	143	cm
-	Maximum weight	150	kg
-	Duration of complete lifting movement	45	sec
-	Total weight	104	kg

Battery PowerMOVE Mini touch&move 3.1	
Part	Specifications
Battery type	Gel battery
Voltage	2x 12 V
Battery capacity	12.3 Ah
Battery charger type Mascot 2440	
Mains electricity (input)	100-240 V ac 50-60 Hz
Output	24VDC max 4A

Weighing unit PowerMOVE touch&move	
Part	Specifications
Maximum lifting weight / weighing weight	200 kg
Resolution	0.1 kg
Accuracy	0.1 %
Weighing unit dimensions	approx. 80x207x78 mm
Power supply	Battery 9 V
Number of weighings with full battery	approx. 3000

Annex B: Identification labels

Explanation symbols



Read the user manual before use



Serial number



CE marking
Regulation (EU) 2017/745
Medical Devices Class I



Production date



Medical device



Manufacturer

PowerMOVE Mini touch&move





PowerMOVE Mini
touch&move 3.1
MAX 200 KG

Voltage 24V DC Cap. 10Ah IPx2

 Read the manual before use.
Charge only with supplied charger.

 Regulation (EU) 2017/745
NEN-EN-ISO 10535

 Medical device class I

 XXX 000 0000

 Year-week 2021-35

 GTIN (01)
BATCH/LOT (10)
SERIAL (21)

 JOYinCARE
Industrieweg 47, 8071 CS Nunspeet
T. 0341-768080 info@joyincare.com

PowerMOVE Mini touch&move with weighing unit





PowerMOVE Mini
touch&move 3.1
with weighing unit
MAX 200 KG

Voltage 24V DC Cap. 10Ah IPx2

 Read the manual before use.
Charge only with supplied charger.

 Regulation (EU) 2017/745
NEN-EN-ISO 10535

 Medical device class I







 XXX 000 0000

 Year-week 2021-35







 GTIN (01)
BATCH/LOT (10)
SERIAL (21)

 JOYinCARE
Industrieweg 47, 8071 CS Nunspeet
T. 0341-768080 info@joyincare.com









4-point electric spreader bar

		<h3>4-point electric spreader bar MAX 200 KG</h3>	
	Medical device class I		Read user manual before use.
	XXX 000 0000		Regulation (EU) 2017/745 NEN-EN-ISO 10535
	Year-week 2021-35		JOYinCARE Industrieweg 47, 8071 CS Nunspeet T. 0341-768080 info@joyincare.com

2-point spreader bar

		<h3>2-point spreader bar MAX 200 KG</h3>	
	Medical device class I		Read user manual before use.
	XXX 000 0000		Regulation (EU) 2017/745 NEN-EN-ISO 10535
	Year-week 2021-35		JOYinCARE Industrieweg 47, 8071 CS Nunspeet T. 0341-768080 info@joyincare.com

Widening barWidening bar

		<h3>Widening bar MAX 200 KG</h3>	
	XXX 000 0000		Medical device class I
	Year-week 2023-16		Read user manual before use.
	GTIN (01) BATCH/LOT (10) SERIAL (21)		Regulation (EU) 2017/745 NEN-EN-ISO 10535
			JOYinCARE Industrieweg 47, 8071 CS Nunspeet T. 0341-768080 info@joyincare.com



www.joyincare.com

JOYinCARE.